

1 **STH250230CM**
stophold sostegno cromo lucido, 230mmx250mm (hxb)
stophold haltebügel, hochglanz- verchromt, 230mmx250mm (hxb)
stophold display holder, high-gloss chrome-plated, 230mmx250mm (hxb)



2 **STB305240GL**
stopbag tasca portadepliant in acrilico color vetro, spessore 3mm, per formato DIN A4, inclinata di circa 30°, adatta per circa 200 fogli singoli
stopbag acrylglas prospekttasche, 3mm, DIN A4 format, 30° neigung für ca. 200 einzelblattprospekte
stopbag glassgreen acrylic brochure pocket, thickness 3mm for DIN A4 format, inclination 30° for approx. 200 single sheet brochures



5 stopquick

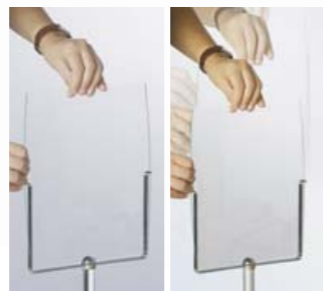

3 stopup

1 stophold

STQ302240GL
stophold sostegno cromo lucido, 230mmx250mm (hxb)
stophold haltebügel, hochglanz- verchromt, 230mmx250mm (hxb)
stophold display holder, high-gloss chrome-plated, 230mmx250mm (hxb)



5

STPQ1A4
STPQ2A4
stoppix A4 monofacciale e bifacciale: poster display privo di cornici, policarbonato trasparente
stoppix A4 ein- und doppelseitig: rahmenloses posterdisplay, transparentes polycarbonat
stoppix A4 single- and double-sided: frameless poster display, transparent polycarbonate



6



7

STF302240GL
stopfix pannello singolo per informazioni in acrilico color vetro, spessore 3mm, per formato DIN A4, mono- e bifacciale, per cartelli di direzione e di indicazione
acrylglas-infoschild stopfix im DIN A4 format, stehend, ein- und beidseitige ansicht, für individuelle gestaltung und beschriftung
glass-green acrylic information sign stopfix in DIN A4 format, vertical, front and rear view, for individual design and print



8

accessories



3 **STU305240GL**
stopup portaposter a tasca in acrilico color vetro, spessore 3mm, per formato DIN A4, inclinato di 45°, inserimento del foglio laterale
stopup acrylglas-posterhalter 3mm stark für ein einzelblatt im DIN A4 format, 45° neigung, seitlicher ein Schub
stopup glassgreen acrylic poster holder, thickness 3mm, for one single sheet in DIN A4 format, inclination 45°, insertion sideways



4 **STS303240GL**
ripiano stopshelf in acrilico color vetro, spessore 3mm, per formato DIN A4, inclinato di 45°, profondità del ripiano 40mm
acrylglas-ablage stopshelf 3mm stark für DIN A4 format, 45° neigung, ablagetiefe 40mm
stopshelf glass-green acrylic shelf, thickness 3mm for DIN A4 format, inclination 45°, shelf depth 40mm

IT moltiplicate le funzioni stopper del vostro sistema stopper, attacco a muro o tex. semplicemente avvitare il sostegno universale ad U, scegliere ed inserire i supporti in acrilico nel sostegno ad U. tutti i supporti sono intercambiabili. ns. consiglio: tali supporti in acrilico sono compatibili anche con il nostro flip e flippy, della linea zip.

DE erweitern sie mit den stopper accessoires stopper, stopper wandhalter oder tex. universal haltebügel stophold einfach aufgeschraubt, das passende acrylglas-display auswählen und einschieben. displays können jederzeit gewechselt werden. unser tip: alle displays passen auch zu flip und flippy der zip serie.

EN upgrade your stopper, stopper wall or tex system with the accessories. stophold support is simply screwed on all stopper versions. then choose the needed acrylic glass display and insert it into stophold. you can replace the displays anytime. our tip: all displays match also with the zip items flip and flippy.

stopper accessories

n° articolo artikelnr. product nr.		
1	STH250230CM	stophold, 1pc
2	STB305240GL	stopbag, 1pc
3	STU305240GL	stopup, 1pc
4	STS303240GL	stopshelf, 1pc
5	STQ302240GL	stopquick, 1pc
6	STPQ1A4	stoppix one side, 1pc
7	STPQ2A4	stoppix double side, 1pc
8	STF302240GL	stopfix, 1pc
9	STT400400B	stoptable, 1pc

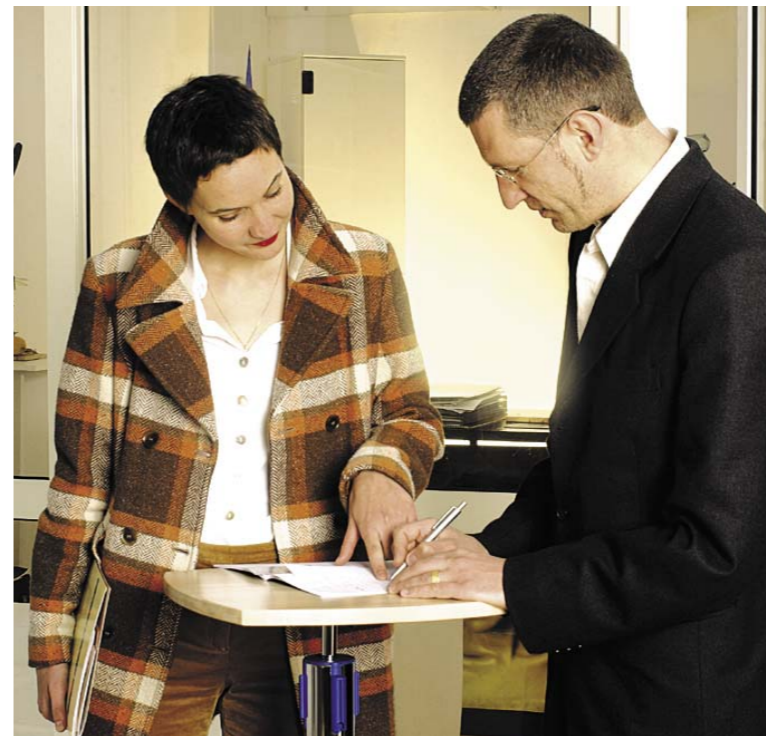

STT400400B
stoptable: tavolino in faggio massiccio, 400x400x20mm. materiale per il montaggio incluso
stoptable: tischplatte, buche massiv, 400x400x20mm inkl. montage material
stoptable: desk top, solid beech wood, 400x400x20mm incl. mounting material



stopper

sistemi guidalinee | personenleitsysteme | crowd control



table:

1 STROVE
rondo vetro: tavolino in vetro temperato, 480x480mx20mm
rondo glas: tischplatte, temperiertes glas 480x480mx20mm
rondo glass: table top, tempered glass, 480x480mx20mm

2 STROAR
rondo argento: tavolino in mdf color argento, 480x480mx20mm
rondo glas: tischplatte, mdf silber lackiert 480x480mx20mm
rondo glass: table top, tempered glass, 480x480mx20mm

base:

4 STKABSAR
base protezione: abs stampato ad iniezione color argento con piastra
basis trittschuttring: abs-spritzgussversilbert mit bodenplatte
base step on protection: abs mold injection, silver plated with weight plate

5 STKINSAL
inserto decorativo: alluminio anodizzato color argento
dekor inlay: silber eloxiertes aluminium
decorative inlay: silver anodized aluminium

post:

3 STATUAL
tubo per tavolo: tubo in alluminio anodizzato color argento
pfosten für tische: silber eloxiertes aluminium
post for table: silver anodized aluminium



rondo

vantaggioso: più superfici pubblicitarie a disposizione nella base e sul tavolino
mehr wert für sie: zusätzliche werbeflächen in basis und tischplatte
your surplus: additional marketing space in base and on the top



IT assicurarsi superfici polivalenti con il tavolo rondo della gamma stopper: per la base si può scegliere tra tutti gli elementi della linea stopper master. i tavolini sono disponibili sia in vetro che in argento. si possono combinare anche entrambi i tipi, ottenendo così una superficie personalizzabile. inoltre si può aggiungere la base in vetro, da personalizzare tramite un print inlay. anche gli accessori stopper sono combinabili con queste varianti, tramite un facile avvitamento. rondo si monta facilmente, e grazie alle molteplici superfici pubblicitarie, è consigliato specialmente per fiere, eventi, negozi, showroom ed uffici.

DE mit den rondo tischen aus dem stopper programm mehrwert sichern: für die basis stehen ihnen alle elemente der stopper master basis zur auswahl. tischplatten sind in glas oder silber erhältlich. oder sie kombinieren beide platten miteinander und erhalten eine schnell personalisierbare werbefläche. dazu passt die ebenfalls schnell mit printinlay gestaltete basis mit glaseinsatz. selbst stopper accessoires passen dazu: einfach zum aufschrauben. rondo ist schnell aufgestellt und empfiehlt sich v.a. durch seine zusätzlichen marketing flächen für messen, events, shop, showroom und office.

EN gain publicity space with the rondo tables: for the base you can choose out of all elements of the master base. the table tops are available in glass or silver. you can also combine both tops with each other and get a quick customizable new marketing area. matching with this is the base with glass inset, customized with a print inlay in no time at all. even the stopper accessories match with this: just screw them on top. rondo is set up in no time and thanks to its additional ad spaces it is especially recommended for exhibitions, events, shops, showrooms and offices.

rondo

n° articolo | artikelnr. | product nr.

1	STROVE	rondo table top glass, 1pc
2	STROAR	rondo table top silver, 1pc
3	STATUAL	table post silver anodized aluminium, 1pc
4	STKABSAR	base abs ring silver, 1pc
5	STKINSAL	base inlay aluminum silver, 1pc

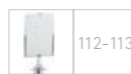

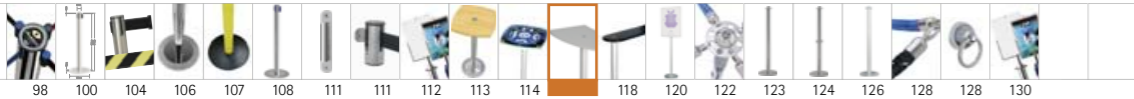

table:

1 **STTWAR**
wave: tavolino in mdf verniciato in color argento, 689x400x417mm, con viti e connettori
wave: tischplatte, mdf silber lackiert, 689x400x417mm, schrauben, plattenverbinder
wave: table top, mdf silver coated, 689x400x417mm, with screws and connectors

base:

3 **STKABSAR**
base protezione: abs stampato ad iniezione color argento con piastra
basis trittschutzring: abs-spritzgussversilbert mit bodenplatte
base step on protection: abs mold injection, silver plated with weight plate

4 **STKINSAL**
inserto decorativo: alluminio anodizzato color argento
dekor inlay: silber eloxiertes aluminium
decorative inlay: silver anodized aluminium

post:

2 **STATUAL**
tubo per tavolo: tubo in alluminio anodizzato color argento
pfosten für tische: silber eloxiertes aluminium
post for table: silver anodized aluminium

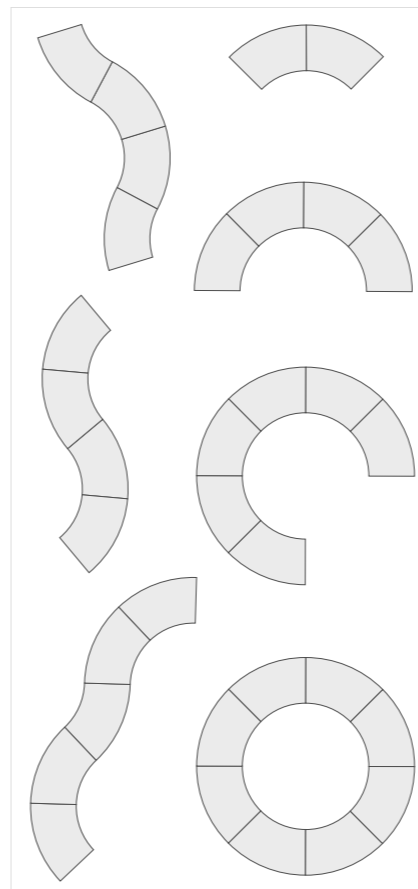

wave

connettore: semplice e veloce
verbinder: schnell und einfach
connector: quick and easy



IT create dei ripiani modulari con i tavolini wave: ondulari, a cerchio o semicerchio, oppure in segmenti, a seconda delle proprie esigenze: per la base potete scegliere tra tutti gli elementi della linea stopper master. tramite un inlay su vetro si può per esempio personalizzare facilmente la base con delle stampe. ogni tavolino viene fornito con i connettori appositi. collegate wave in sale di attesa, decorate stand fieristici oppure create delle barriere per eventi particolari.

DE mit wave tischen können sie modular theken zaubern: wellenförmig, als kreise, halbkreise oder segmente ganz nach bedarf. als basis können sie alle elemente der stopper master basis verwenden. mit glasinlay lässt sich die basis zum beispiel mit druck personalisieren. jede tischplatte hat die passenden verbinder schon dabei. binden sie wave in wartebereiche ein, gestalten sie messestände oder abspernungen bei events.

EN create modular counters with the wave tables: s-shaped, in circles, semi-circles or segments always according to your needs. for the base all elements of the stopper master base can be choosen. with glass inlay the base can be customized easily with prints. every table top comes already with the matching connectors. integrate wave in waiting areas, design fair stands or create barriers for events.

wave

n° articolo | artikelnr. | product nr.

1	STTWAR	table top wave silver, 1pc
2	STATUAL	table post silver anodized aluminium, 1pc
3	STKABSAR	base abs ring silver, 1pc
4	STKINSAR	base inlay aluminum silver, 1pc



stopper

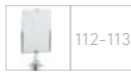

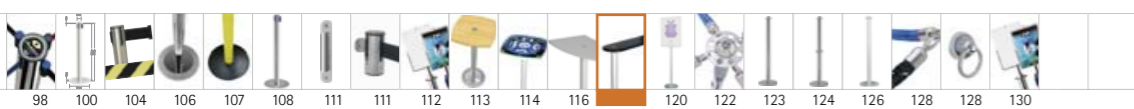

table:

1 **STLT1260SZ**
longtable: tavolino in mdf nero, 240x1620mm
longtable: tischplatte mdf schwarz durchgefärbt 240x1620mm
longtable: table top mdf black, 240x1620mm

2 **STLTCON**
connettore: per unire i tavoli longtable, alluminio anodizzato
verbinder: für longtable tische, eloxiertes aluminium
connector: for longtable, anodized aluminium

base:

4 **STKABSAR**
base protezione: abs stampato ad iniezione color argento con piastra
basis trittschuttring: abs-spritzguss versilbert mit bodenplatte
base step on protection: abs mold injection, silver plated with weight plate

5 **STKINSAL**
inserto decorativo: alluminio anodizzato color argento
dekor inlay: silber eloxiertes aluminium
decorative inlay: silver anodized aluminium

post:

3 **STTATUAL**
tubo per tavolo: tubo in alluminio anodizzato color argento
pfosten für tische: silber eloxiertes aluminium
post for table: silver anodized aluminium



longtable

6 **STLTB910**
banner avvolgibile: bianco 900x930mm (hxb) adatto anche per banner stampati
rollbanner: weisser stoff 900x930mm (hxb), auch für bedruckte banner geeignet
roll banner: white 900x930mm (hxb), use also with your printed banner



IT longtable é modulare e personalizzabile. per la base si possono scegliere tutti gli elementi della linea stopper master. il tavolo longtable é fatto in mdf di color nero, quindi particolarmente robusto e durevole. i connettori permettono di collegare i longtable sia in linea retta che obliquamente. per la personalizzazione vi offriamo il banner avvolgibile: potete sostituire la stoffa contenuta nella confezione con un banner stampato da voi.

DE longtable ist modular und personalisierbar. sie können aus dem master programm alle elemente für die basis wählen. der longtable top ist schwarz durchgefärbtes mdf. daher besonders robust und langlebig. die connector sind so gestaltet, dass sie die longtables nicht nur gerade, sondern auch gewinkelt miteinander verbinden können. für die personalisierung bieten wir ihnen rollbanner. den mitgelieferten stoff können sie einfach mit einem von ihnen bedruckten banner austauschen.

EN longtable is modular and customizable. you can choose all elements out of the master base assortment for your base. the longtable is black solid coloured mdf and thus especially robust and durable. the connectors allow you to merge your longtable straight but also angulated. customizing is easy with the rollbanners. you can simply exchange the supplied fabric with your printed banner.

longtable

n° articolo artikelnr. product nr.	
1	STLT1260SZ longtable black, 1pc
2	STLTCON longtable connector, 1pc
3	STTATUAL table post silver anodized aluminium, 1pc
4	STKABSAR base abs ring silver, 1pc
5	STKINSAR base inlay aluminum silver, 1pc
6	STLTB910 roll banner for longtable, 1pc



rollbanner: semplicemente da appendere ed estrarre. al posto della versione neutra si può attaccare con nastro biadesivo un banner personalizzato.

rollbanner: einfach einhängen, ausziehen. statt des neutralen kann ein bedrucktes banner einfach mit doppelkleber befestigt werden.

rollbanner: just hook in and pull out. instead of the white fabric a banner customized with print can be used. mount with double adhesive tape.



stopper

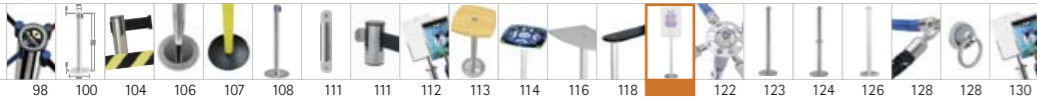

- STIFA3
- STIF700500
- STIF1000700

stopinfo: base di protezione abs con inserto in alluminio, profili in alluminio anodizzato, metallo verniciato argento, tasca portaposter in acrilico con calamita per la chiusura, altezza 1m da aggiungere l'altezza della tasca porta poster

stopinfo: basis abs trittschutz mit alu einsatz, silber eloxierte aluminium profile, silber lackiertes metall, transparente acryl poster tasche mit magnetverschluss. höhe 1m plus postertasche.

stopinfo: base with abs step-on protection and aluminium inset, silver anodized aluminium profiles, silver coated metal, transparent acrylic poster bag with magnet. height 1m plus poster pocket.

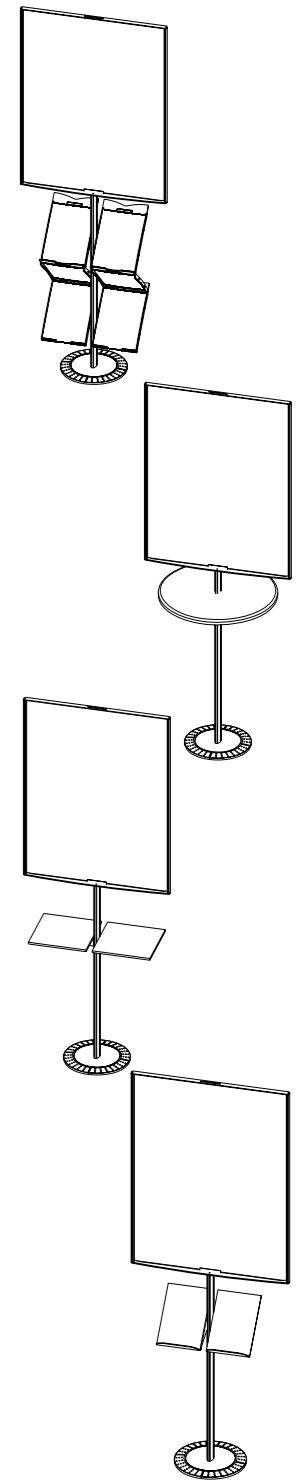

stopinfo



IT il grande info stopper è un degno elemento della linea stopper: disponibile nei tre formati poster standard e composto da materiali di alta qualità. grazie alla chiusura con calamita il cambio delle informazioni è semplice e possibile in ogni momento. stopinfo si monta in un batter d'occhio: avvitare il profilo nella base ed infine montare la tasca porta poster.

DE passend zur stopperserie der grosse info stopper. in drei gängigen postergrößen und mit hochwertig verarbeiteten materialien. durch die bewährte verschlusstechnik mit magnet ist der informationsaustausch jederzeit unproblematisch. stopinfo ist im nu aufgestellt: das profil wird auf die basis montiert und anschliessend die postertasche aufgeschraubt.

EN matching with the stopper programm is the big info stopper. in three common poster sizes and with high-grade materials. thanks to the locking with magnet the exchange of information is anytime easily and without problem. stopinfo is set up in no time: just mount the extrusion on the base and then screw on the poster pocket.

stopinfo

n° articolo artikelnr. product nr.	
1	STIFA3 stopinfo A3, 1pc
2	STIF700500 stopinfo 700x500, 1pc
3	STIF1000700 stopinfo 1000x700, 1pc

up-grade: possibili aggiunte come ripiani, tasche porta depliant o display per il proprio stopinfo personalizzato. contattateci pure per consigli e suggerimenti.

up-grade: mögliche add-on produkte wie ablagen, prospektaschen oder infodisplay, für ihren persönlichen stopinfo. fragen sie uns, wir beraten sie gerne.

up-grade: possible add-on products like shelves, brochure pockets or displays for your personal stopinfo. please contact us for further details, it's our pleasure to assist you.